

hydroo [®]	Product information VDROO3-10	Manufacturer	Hydroo
		Address	
Project Name		Contact	(+34) 972 394 654
		Date	2021/09/06
Station Number		Client Name	GK Electropompa
		Client Addr.	Russia, Moscow
		Contacts	
		Contact	7(495)981-92-44(45)

Product No.	VF3-10R 0110 T 2340 5 2 IE3
-------------	-----------------------------

Product picture(Note: the picture may not be the same as t	Series description
	<p>VDROO is a new series of vertical multistage centrifugal pumps made by Hydroo. It includes different versions: VF, VX, VN and VD and their corresponding pumps sets with motor and with variable frequency drivers.</p> <p>VDROO range has been designed to meet the highest demanding in pumping installations. It has been designed, engineered, industrialized and finally, is being produced in the main factory of Hydroo in Palol de Revardit, Catalonia-Spain.</p>

Performance Data

Rated flow(m ³ /h)	3
Rated head(m)	59
Efficiency(%)	58
Rated power(kW)(kW)	0.832
NPSHr(m)	1.4
Impeller Dia(mm)	82
Rate Speed(rpm)	2900
Impeller stage	10
Min. Flow (m ³ /h)	1.2
Max. Flow (m ³ /h)	4.4
Max. Efficiency (%)	58
MEI	0,8
Pump Weight (kg)	33

MATERIAL

Impeller/Diffuser/Casing	AISI 304
Rubber code	E
Inlet & Outlet chamber	ASTM 25B

INSTALLATION

Connection Code	R
Connection type	Threaded Round flange
Max. pressure (bar)	23
Low/High Temperature()	-15 / 120
Pressure rating	PN25-40
Inlet & Outlet Connection	DN25
Max. Environment temperatu	40

MOTOR

Number of Motor Phases	3~
Protection Class	IP55
Insulation Class	F
Motor Power (kW)	1.1
Frequency(Hz)	50
Rated speed(rpm)	2900
Rated voltage (V)	230/400
Rated current (A)	4.0/2.3
cos	0.83
Energy efficiency Level	IE3

hydroo [®]	Product information VDROO3-10	Manufacturer	Hydroo
		Address	
		Contact	(+34) 972 394 654
		Date	2021/09/06
Project Name		Client Name	GK Electropompa
		Client Addr.	Russia, Moscow
Station Number		Contacts	
		Contact	7(495)981-92-44(45)

Efficiency100%	82.7
Efficiency75%	83.6
Efficiency50%	83
Drive end bearing	6204ZZ
Non-drive end bearing	6204ZZ
Motor Weight (kg)	11.5
SEAL	
Mechanical Seal	D12 WBE4

hydroo [®]	Performance Curve VDROO3-10	Manufacturer	Hydroo
		Address	
Project Name		Contact	(+34) 972 394 654
		Date	2021/09/06
Station Number		Client Name	GK Electropompa
		Client Addr.	Russia, Moscow
		Contacts	
		Contact	7(495)981-92-44(45)

Medium Name Water , Temperature°C, Density1000kg/m³, Viscosity1mm²/s, (ISO99062012 Grande 3B)

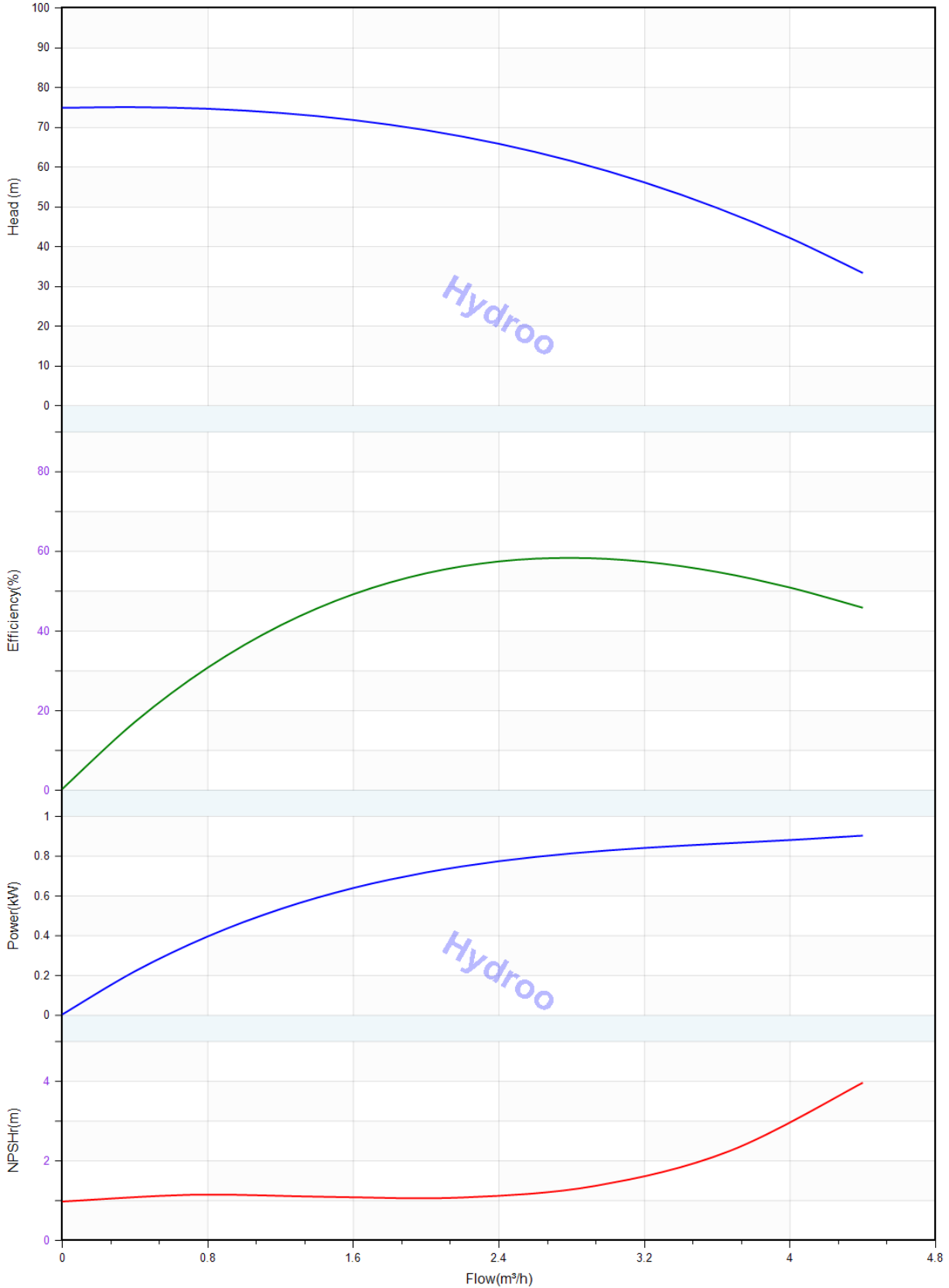

hydroo [®]	Pump technical parameters VDROO3-10	Manufacturer	Hydroo
		Address	
Project Name		Contact	(+34) 972 394 654
		Date	2021/09/06
Station Number		Client Name	GK Electropompa
		Client Addr.	Russia, Moscow
		Contacts	
		Contact	7(495)981-92-44(45)

Rated parameters	
Pump model	VDROO3-10
Product No.	VF3-10R 0110 T 2340 5 2 IE3
Rated flow(m ³ /h)	3
Rated pressure(m)	59
Rated efficiency(%)	58
Power(kW)	0.832
NPSHr(m)	1.4
Speed(rpm)	2900

Medium	
Medium Name	Water
Working temperature(°C)	20
Medium density(kg/m ³)	1000
Viscosity(mm ² /s)	1

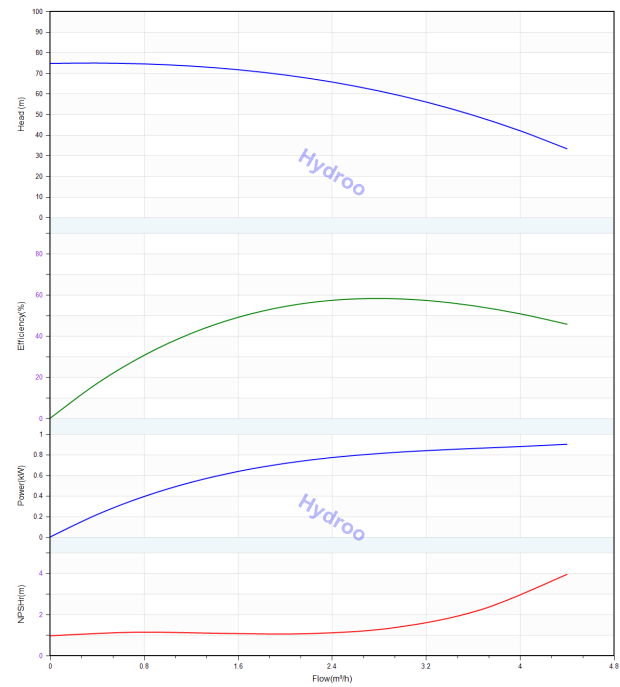

hydroo [®]	Structure picture VDROO3-10	Manufacturer	Hydroo
		Address	
Project Name		Contact	(+34) 972 394 654
		Date	2021/09/06
Station Number		Client Name	GK Electropompa
		Client Addr.	Russia, Moscow
		Contacts	
		Contact	7(495)981-92-44(45)

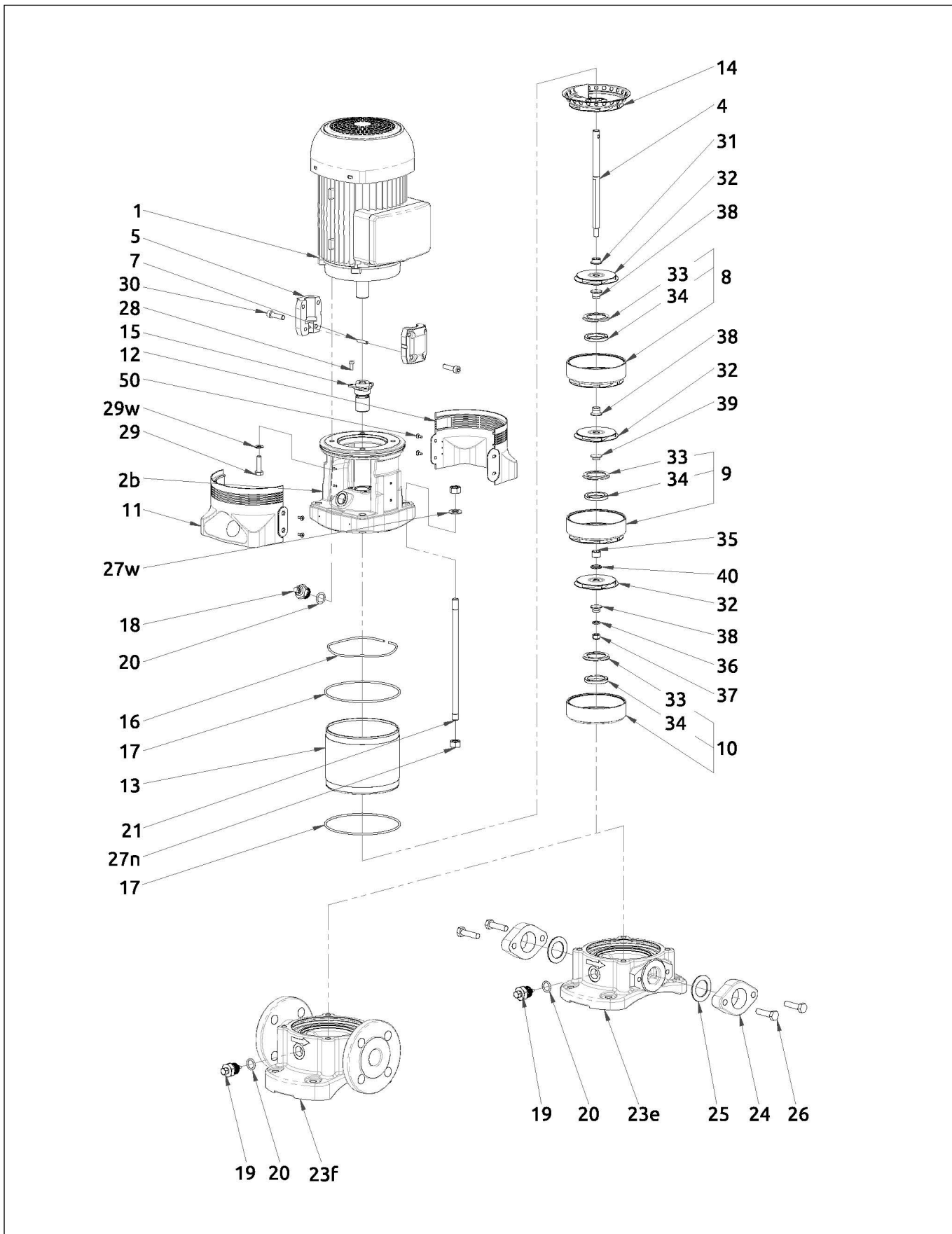

hydroo [®]	Installation picture VDROO3-10	Manufacturer	Hydroo
		Address	
Project Name		Contact	(+34) 972 394 654
		Date	2021/09/06
Station Number		Client Name	GK Electropompa
		Client Addr.	Russia, Moscow
		Contacts	
		Contact	7(495)981-92-44(45)

